

Version : 1.2

液晶之友 电话: 020-33819057
Http://www.lcdfriends.com

TECHNICAL SPECIFICATION

MODEL NO. : V16C6448AC

Customer's Confirmation

Date _____

By _____

PVI's Confirmation

Confirmed By _____

Prepared By _____

PRIME VIEW INTERNATIONAL CO.,LTD.
3,LI SHIN RD. 1,SCIENCE-BASED INDUSTRIAL
PARK,HSINCHU,TAIWAN,R.O.C.
<http://www.pvi.com.tw>

Date : Oct. 24, 2000

This technical specification is subject to change without notice.
Please return 1 copy with your signature on this page for approval.

TECHNICAL SPECIFICATION**CONTENTS**

NO.	ITEM	PAGE
-	Cover(V16C6448AC)	1
-	Contents	2
1	Application	3
2	Features	3
3	Mechanical Specifications	3
4	Mechanical Drawing of TFT-LCD module	4
5	Input / Output Terminals	5
6	Absolute Maximum Ratings	7
7	Electrical Characteristics	7
8	Optical Characteristics	16
9	Reliability Test	18
10	Block Diagram	19
11	Packing Diagram	20
-	Revision History	21

1. Application

This product applies computer peripheral, industrial meter, image communication and multi-media.

2. Features

- . Compatible with VGA-480, VGA-400, VGA-350 and free format.
- . Pixel in stripe configuration
- . Slim and compact
- . Display Colors : 262,144 colors
- . Image Reversion : Up/Down and Left/Right
- . Active area / Outline area = 62.3 %
- . Viewing Direction : 6 o'clock
- . Backlight lamps are Replaceable

3. Mechanical Specifications

Parameter	Specifications	Unit
Screen Size	6.4 (diagonal)	inch
Display Format	640× R, G, B× 480	dot
Active Area	129.6(H)× 97.44 (V)	mm
Dot Pitch	0.0675 (H)× 0.203 (V)	mm
Pixel Pitch	0.203 (H)× 0.203 (V)	mm
Pixel Configuration	Stripe	
Outline Dimension	See Mechanical Drawing	mm
Weight	335	g

4. Mechanical Drawing of TFT-LCD Module

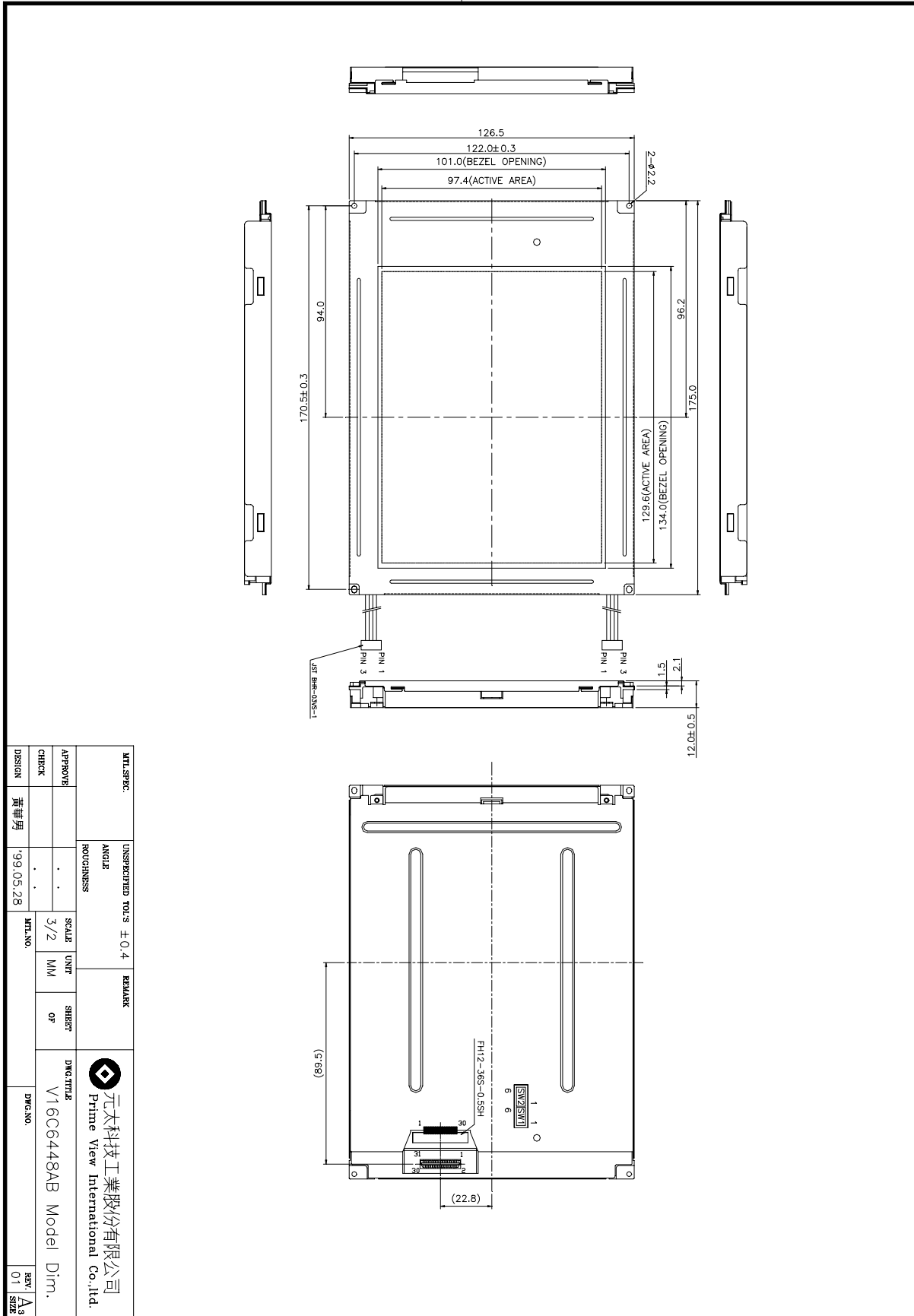

5.Input / Output Terminals

5-1) TFT-LCD Panel Driving

Pin No.	Symbol	Function	Remark
1	GND	Ground (0V)	
2	CLK	Clock Signal for Sampling Image Digital Data	
3	Hsync	Horizontal Synchronous Signal	Note 5-1
4	Vsync	Vertical Synchronous Signal	Note 5-1
5	GND	Ground (0V)	
6	R0	Red Image Data Signal (LSB)	
7	R1	Red Image Data Signal	
8	R2	Red Image Data Signal	
9	R3	Red Image Data Signal	
10	R4	Red Image Data Signal	
11	R5	Red Image Data Signal (MSB)	
12	GND	Ground (0V)	
13	G0	Green Image Data Signal (LSB)	
14	G1	Green Image Data Signal	
15	G2	Green Image Data Signal	
16	G3	Green Image Data Signal	
17	G4	Green Image Data Signal	
18	G5	Green Image Data Signal (MSB)	
19	GND	Ground (0V)	
20	B0	Blue Image Data Signal (LSB)	
21	B1	Blue Image Data Signal	
22	B2	Blue Image Data Signal	
23	B3	Blue Image Data Signal	
24	B4	Blue Image Data Signal	
25	B5	Blue Image Data Signal (MSB)	
26	GND	Ground (0V)	
27	DENB	Disable	
28	VCC	DC +5.0V Power Supply	
29	VCC	DC +5.0V Power Supply	
30	R/L	Horizontal Image Shift-direction Select Signal	Note 5-2
31	U/D	Vertical Image Shift-direction Select Signal	Note 5-3

Note 5-1 : The TFT-LCD module is compatible with four kinds of VGA timing. They are VGA-480, VGA-400, VGA-350 and freedom mode. The polarization of Hsync and Vsync determine the timings.

	VGA-480	VGA-400	VGA-350	Freedom Mode
Hsync Polarization	Negative	Negative	Positive	Positive
Vsync Polarization	Negative	Positive	Negative	Positive

Note 5-2 : R/L is the Right/Left shift signal.

(1). R/L= High, U/D= Low

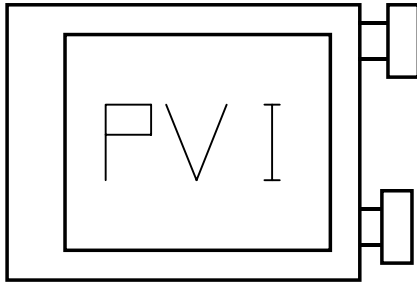

(2). R/L= Low, U/D= Low

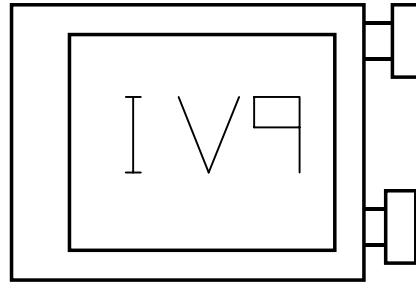

Note 5-3 : U/D is the Up/Down shift signal.

(1). R/L= High, U/D= Low

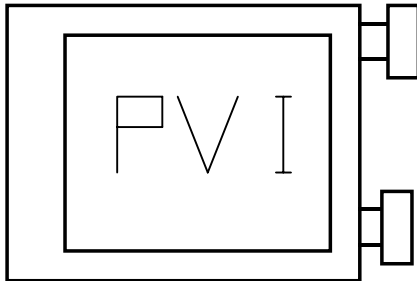

(2). R/L= High, U/D= High

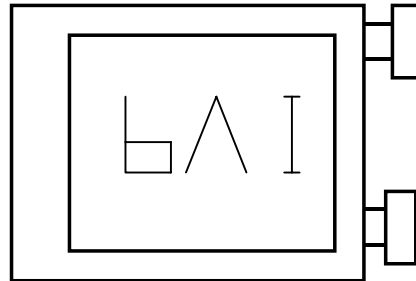

5-2) Backlight driving

Pin No	Symbol	Description	Remark
1	VL1	Input terminal (Hi voltage side)	
2	NC	No Connection	
3	VL2	Input terminal (Low voltage side)	Note 5-4

Note 5-4 : Low voltage side of backlight inverter connects with ground of inverter circuits.

5-3) Input / Output Connector

A) LCD module connector (Reference)
DF9A-31P-1V

B) Backlight Connector

JST BHR-03VS-1

Pin No. : 3

Pitch : 4 mm

Red: High Voltage

White: Low Voltage

6. Absolute Maximum Ratings:

GND=0V, Ta=25°C

Parameters	Symbol	MIN.	MAX.	Unit	Remark
+5V Supply Voltage	V _{CC}	0.0	+6.0	V	
Input Signals Voltage	V _{sig}	-0.3	V _{CC} +0.3	V	Note 6-1
Storage Temperature	T _{stg}	-25	+70	°C	Note 6-2
Operating Temperature	T _{opa}	-0	+55	°C	

Note 6-1: Input signals include CLK, Hsync, Vsync, DENB, R[0:5], G[0:5] and B[0:5].

Note 6-2: Humidity : 95% RH Max. at Ta ≤ 40°C.

Maximum wet-bulb temperature is at 39 °C or less at Ta > 40 °C.

No condensation.

7. Electrical Characteristics
7-1) Recommended Operating Conditions:

A) Driving for TFT-LCD panel

GND = 0V , Ta = 25 °C

Parameters	Symbol	Min.	Typ.	Max.	Unit	Remark
+5V Supply Voltage	V _{CC}	+4.75	+5.0	+5.25	V	
Supply Input Ripple Voltage	V _{CCRP}			0.1	Vp-p	V _{CC} =+5V
Input Signals Voltage (High)	V _{IH}	+2.6			V	
Input Signals Voltage (Low)	V _{IL}			+0.5	V	

B) Driving for backlight

Ta = 25 °C

Item	Symbol	Min.	Typ.	Max.	Unit	Remark
Tube Current	I _f	-	6	-	mA	
Tube Voltage	V _L	-	380	-	Vrms	
Oscillation		-	35	-	KHz	
Lamp Life Time		-	20,000	-	Hr	

7-2) Power Consumption

Parameters	Symbol	Typ.	Max.	Unit	Remark
+5V Current Dissipation	I _{CC}	260	300	mA	
Input Signals Current (High)	I _{IH}		100	μA	V _{IH} =+5V
Input Signals Current (Low)	I _{IL}		100	μA	V _{IL} =0V
LCD Panel Power Consumption		1.3		W	Note 7-1
Backlight Power Consumption		4.56		W	Note 7-2

Note 7-1 : The power consumption of backlight is not included.

Note 7-2 : Backlight lamp power consumption is calculated by $I_L \times V_L$.

7-3) Input / Output signal timing chart

Parameters		Symbol	Format	Min.	Typ.	Max.	Unit	Note
	Frequency	$F_c=1/T_c$	All		25.175		MHz	Note 7-3
Clock	High Time	Tckh	All	10			ns	
	Low Time	Tckl	All	10			ns	
	Periodic = Line	Thp	All		31.778		μs	Note 7-3
Hsync					800	1024	clock	Note 7-3
	Pulse Width	Thpw	All	2	96	200	clock	
	Back Porch	Thbp	All	2	48	64	clock	
			VGA-480	515	525	1024	line	Note 7-3
	Periodic = Frame	Tvp	VGA-400	447	449	1024	line	Note 7-3
			VGA-350	447	449	1024	line	Note 7-3
Vsync			Freedom Mode			1024	line	
	Pulse Width	Tvpw	All	1	2		line	
	Back Porch	Tvbp	All	1		64	line	
Data	Setup Time	Tds	All	10			ns	
	Hold Time	Tdh	All	10			ns	
	Periodic = Line	Tep	All		800	1024	clock	
	Pulse Width (H)	Tepw	All	2	640	800	clock	
DENB			VGA-480	480	480		line	
	Display Line No(V)	Tvd	VGA-400	400	400		line	
			VGA-350	350	350		line	
			Freedom Mode		480		line	
Horizontal Display Periodic		Thd	All	640	640	640	clock	
Hsync-CLK Phase Difference		Thc	All	10		Tc-10	ns	
Vsync-Hsync Phase Difference		Tvh	All	1		Thp-1	clock	

Note 7-3 : T_c is the period of sampling clock. In case of low-frequency, the image-flicker may occur.

7-4) Display Time Range

(1) Vertical Timing :

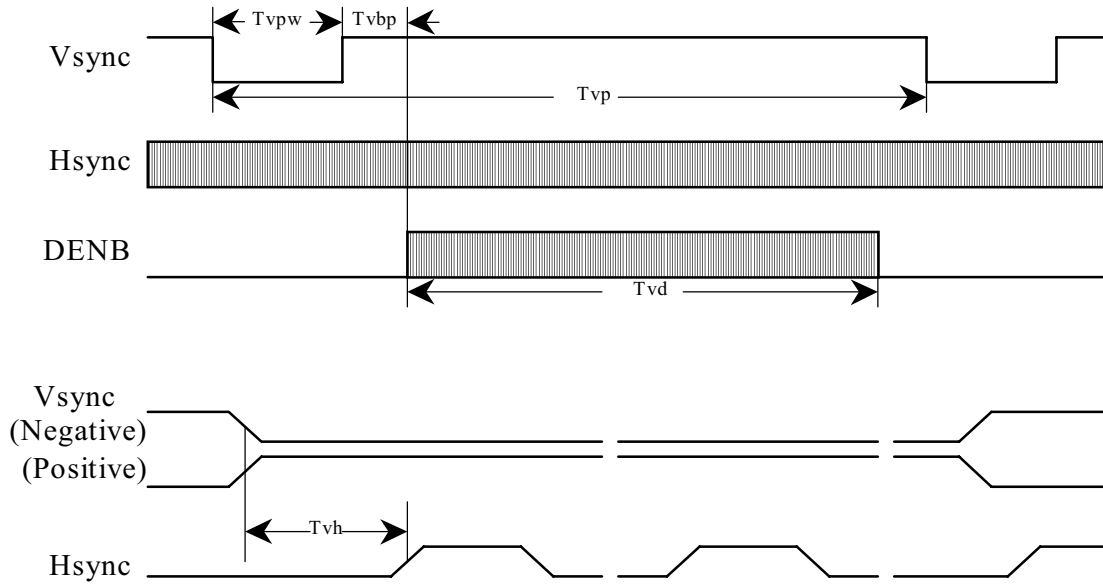

(2) Horizontal Timing :

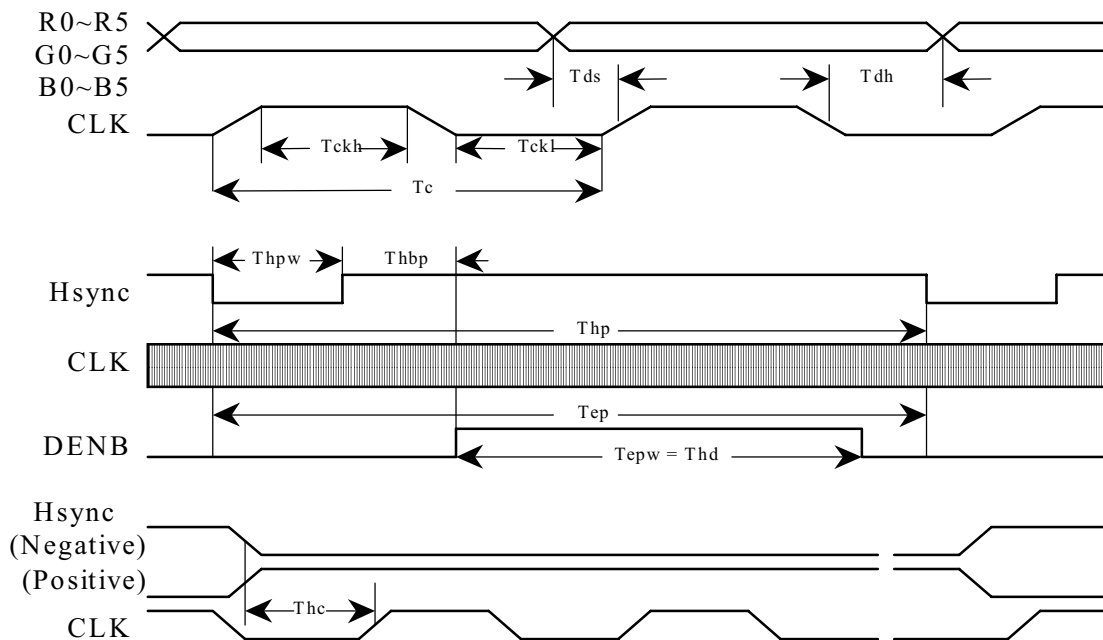

(3). Detail of Horizontal Timing :

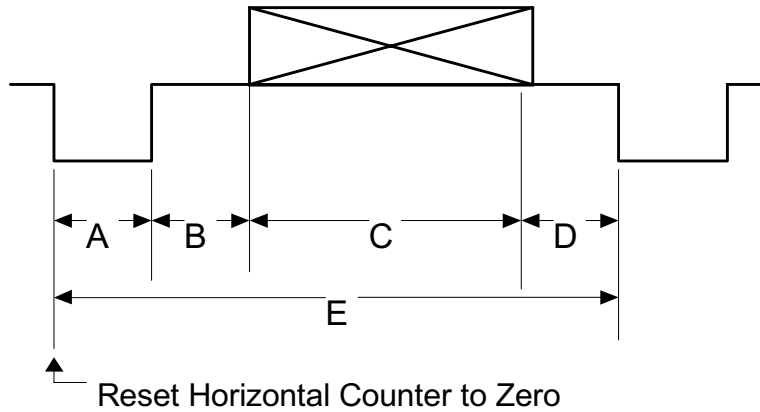

(a). VGA-480 Mode (Hsync = Negative Polarization)

Item	Description	Clock Cycles	Time
A	Horizontal Width	96	3.813 μ s
B	Horizontal B-Porch	48	1.907 μ s
C	Horizontal Display	640	25.422 μ s
D	Horizontal F-Porch	16	0.636 μ s
E	Horizontal Total	800	31.778 μ s

(b). VGA-400 Mode (Hsync = Negative Polarization)

Item	Description	Clock Cycles	Time
A	Horizontal Width	96	3.813 μ s
B	Horizontal B-Porch	48	1.907 μ s
C	Horizontal Display	640	25.422 μ s
D	Horizontal F-Porch	16	0.636 μ s
E	Horizontal Total	800	31.778 μ s

(c). VGA-350 Mode (Hsync = Positive Polarization)

Item	Description	Clock Cycles	Time
A	Horizontal Width	96	3.813 μ s
B	Horizontal B-Porch	48	1.907 μ s
C	Horizontal Display	640	25.422 μ s
D	Horizontal F-Porch	16	0.636 μ s
E	Horizontal Total	800	31.778 μ s

(d). Free Format (Hsync = Positive Polarization)

Item	Description	Clock Cycles	Time
A	Horizontal Width	Note 7-3	---
B	Horizontal B-Porch	Note 7-3	---
C	Horizontal Display	Note 7-3	---
D	Horizontal F-Porch	Note 7-3	---
E	Horizontal Total	< 1024	---

(4). Detail of Vertical Timing :

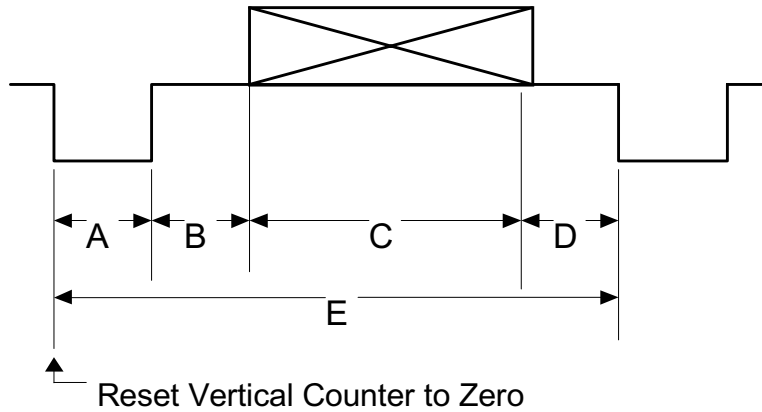

(a). VGA-480 Mode (Vsync = Negative Polarization)

Item	Description	Horizontal Lines	Time
A	Vertical Width	2	63.5 μs
B	Vertical B-Porch	33	1.049 ms
C	Vertical Display	480	15.253 ms
D	Vertical F-Porch	10	317.8 μs
E	Vertical Total	525	16.683 ms

(b). VGA-400 Mode (Vsync = Negative Polarization)

Item	Description	Horizontal Lines	Time
A	Vertical Width	2	63.5 μs
B	Vertical B-Porch	35	1.112 ms
C	Vertical Display	400	12.711 ms
D	Vertical F-Porch	12	381.0 μs
E	Vertical Total	449	14.268 ms

(c). VGA-350 Mode (Vsync = Positive Polarization)

Item	Description	Horizontal Lines	Time
A	Vertical Width	2	63.5 μs
B	Vertical B-Porch	60	1.907 ms
C	Vertical Display	350	11.122 ms
D	Vertical F-Porch	37	1.176 μs
E	Vertical Total	449	14.268 ms

(d). Free Format (Vsync = Positive Polarization)

Item	Description	Horizontal Lines	Time
A	Vertical Width	Note 7-3	---
B	Vertical B-Porch	Note 7-3	---
C	Vertical Display	Note 7-3	---
D	Vertical F-Porch	Note 7-3	---
E	Vertical Total	< 1024	---

7-5) Horizontal Display Position

Horizontal display position depends on the signal of DENB and the input digital image. As the rising edge of DENB signal comes, LCD module will create a horizontal sampling start pulse. At this time, the source driver ICs begin to sample image data and transfer the digital image data to analogue image data by D/A inverters. Then send the analogue image signal to the right position of active display area of the LCD panel. If DENB is low, LCD module will set horizontal display position in default value.

Parameters		Symbol	Format	Min.	Typ.	Max.	Unit	Remark
DENB	Setup Time	Tes	All	10		Tc-10	ns	
	Hold Time	Teh	All	10		Tc-10	ns	
	Pulse Width	Tepw	All	2	640	720	clock	
DENB	Horizontal		VGA-480		144		clock	
Keep	Sampling	Thss	VGA-400		144		clock	
At	Start		VGA-350		144		clock	
“Low”	Pulse Position		Free Format	128		192	clock	Note 7-4
Hsync-DENB Phase Difference		The	All	96		160	clock	

Note 7-4: In free format condition (Hsync = Positive, Vsync = Positive), if DENB is low, the position of horizontal sampling start pulse depends on the seven control lines of HP[6:0] Lattice iSPLSI1032E-LT70 FPGA. The starting position is the count of { 128 + Data(HP[6:0]) } clock.

7-6) Vertical Display Position

Mode	Hsync	Vsync	V-Start Position	V-Display	Remark
VGA-480	Negative	Negative	34	480 lines	
VGA-400	Negative	Positive	17	400 lines	Note 7-5
VGA-350	Positive	Negative	30	350 lines	Note 7-6
Freedom Mode	Positive	Positive	24	480 lines	

Note 7-5: As the format is VGA-400(Hsync = Negative, Vsync = Positive), LCD module will adjust the display area to the center of display. At this time, both of the upper and lower display areas have 40 blanking lines (the display color is black). The actual display area is center 400 lines.

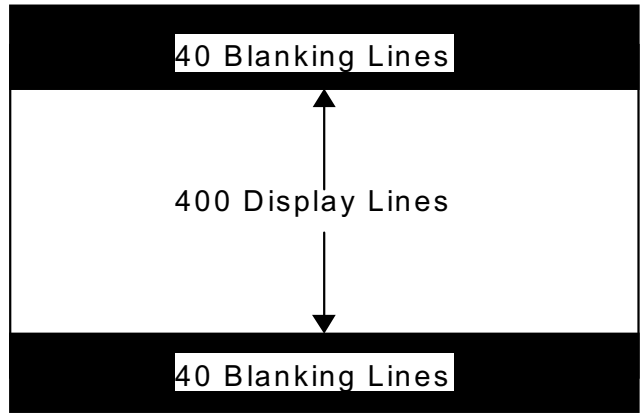

Note 7-6: As the format is VGA-350(Hsync = Negative, Vsync = Positive), LCD module will adjust the display area to the center of display. At this time, both of the upper and lower display areas have 65 blanking lines (the display color is black). The actual display area is center 350 lines.

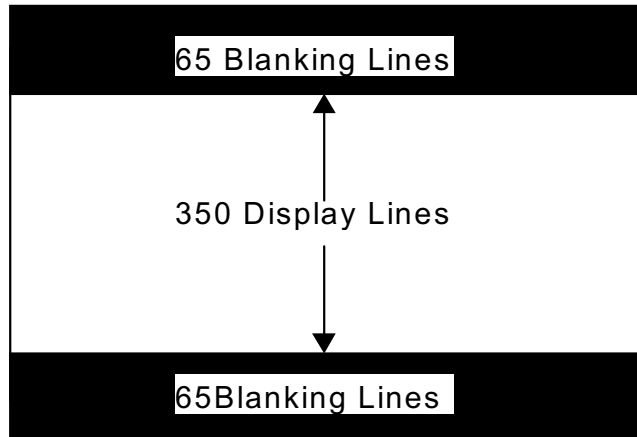

7-6) Pixel Arrangement

The LCD module pixel arrangement is the stripe.

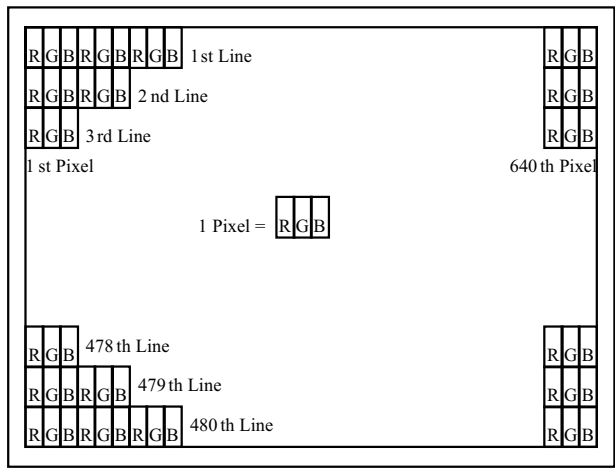

7-7) Display Color and Gray Scale Reference

Color		Input Color Data																	
		Red					Green					Blue							
		R5	R4	R3	R2	R1	R0	G5	G4	G3	G2	G1	G0	B5	B4	B3	B2	B1	B0
Basic Colors	Black	0	0	0	0	0	0	0	0	0	0	0	0	0	0	0	0	0	0
	Red (63)	1	1	1	1	1	1	0	0	0	0	0	0	0	0	0	0	0	0
	Green (63)	0	0	0	0	0	0	1	1	1	1	1	1	0	0	0	0	0	0
	Blue (63)	0	0	0	0	0	0	0	0	0	0	0	0	1	1	1	1	1	1
	Cyan	0	0	0	0	0	0	1	1	1	1	1	1	1	1	1	1	1	1
	Magenta	1	1	1	1	1	1	0	0	0	0	0	0	1	1	1	1	1	1
	Yellow	1	1	1	1	1	1	1	1	1	1	1	1	0	0	0	0	0	0
	White	1	1	1	1	1	1	1	1	1	1	1	1	1	1	1	1	1	1
Red	Red (00)	0	0	0	0	0	0	0	0	0	0	0	0	0	0	0	0	0	0
	Red (01)	0	0	0	0	0	1	0	0	0	0	0	0	0	0	0	0	0	0
	Red (02)	0	0	0	0	1	0	0	0	0	0	0	0	0	0	0	0	0	0
	Darker																		
	↓	↓	↓	↓	↓	↓	↓	↓	↓	↓	↓	↓	↓	↓	↓	↓	↓	↓	↓
	Brighter																		
	Red (61)	1	1	1	1	0	1	0	0	0	0	0	0	0	0	0	0	0	0
	Red (62)	1	1	1	1	1	0	0	0	0	0	0	0	0	0	0	0	0	0
Red (63)	1	1	1	1	1	1	0	0	0	0	0	0	0	0	0	0	0	0	
Green	Green (00)	0	0	0	0	0	0	0	0	0	0	0	0	0	0	0	0	0	0
	Green (01)	0	0	0	0	0	0	0	0	0	0	0	1	0	0	0	0	0	0
	Green (02)	0	0	0	0	0	0	0	0	0	0	1	0	0	0	0	0	0	0
	Darker																		
	↓	↓	↓	↓	↓	↓	↓	↓	↓	↓	↓	↓	↓	↓	↓	↓	↓	↓	↓
	Brighter																		
	Green (61)	0	0	0	0	0	0	1	1	1	1	0	1	0	0	0	0	0	0
	Green (62)	0	0	0	0	0	0	1	1	1	1	1	0	0	0	0	0	0	0
Green (63)	0	0	0	0	0	0	1	1	1	1	1	1	0	0	0	0	0	0	
Blue	Blue (00)	0	0	0	0	0	0	0	0	0	0	0	0	0	0	0	0	0	0
	Blue (01)	0	0	0	0	0	0	0	0	0	0	0	0	0	0	0	0	0	1
	Blue (02)	0	0	0	0	0	0	0	0	0	0	0	0	0	0	0	0	1	0
	Darker																		
	↓	↓	↓	↓	↓	↓	↓	↓	↓	↓	↓	↓	↓	↓	↓	↓	↓	↓	↓
	Brighter																		
	Blue (61)	0	0	0	0	0	0	0	0	0	0	0	0	1	1	1	1	0	1
	Blue (62)	0	0	0	0	0	0	0	0	0	0	0	0	1	1	1	1	1	0
Blue (63)	0	0	0	0	0	0	0	0	0	0	0	0	1	1	1	1	1	1	

7-8)Control Board Dip Switch Format**SW1**

Item	Condition	Remark
SW 1-1	Vertical Shift (1 Line)	Default (ON)
SW 1-2	Vertical Shift (2 Line)	Default (ON)
SW 1-3	Vertical Shift (4 Line)	Default (OFF)
SW 1-4	Vertical Shift (8 Line)	Default (OFF)
SW 1-5	Vertical Shift (16 Line)	Default (OFF)
SW 1-6	Vertical Shift (32Line)	Default (ON)

SW2

Item	Condition	Remark
SW 2-1	Horizontal Shift (1 Line)	Default (ON)
SW 2-2	Horizontal Shift (2 Line)	Default (ON)
SW 2-3	Horizontal Shift (4 Line)	Default (ON)
SW 2-4	Horizontal Shift (8 Line)	Default (ON)
SW 2-5	Horizontal Shift (16 Line)	Default (OFF)
SW 2-6	Horizontal Shift (32 Line)	Default (OFF)

8. Optical Characteristics

8-1) Specification:

Ta=25°C

Parameter		Symbol	Condition	MIN.	TYP.	MAX.	Unit	Remarks
Viewing Angle	Horizontal	θ	CR > 10	± 45	± 55		deg	Note 8-3
	Vertical	θ (to 12 o'clock)		10	15		deg	
		θ (to 6 o'clock)		30	35		deg	
Contrast Ratio		CR		100	120			Note 8-1
Response time	Rise	Tr	$\theta = 0^\circ$			30	ms	
	Fall	Tf				50	ms	
Brightness					300		cd/m ²	Note 8-2
Lamp Life Time					20,000		hr	
White Chromaticity		x		0.264	0.294	0.324	-	
		y		0.276	0.306	0.336	-	
Cross Talk			$\theta = 0^\circ$			3	%	Note 8-4

Note 8-1 : CR = $\frac{\text{Luminance when LCD is White}}{\text{Luminance when LCD is Black}}$

Contrast Ratio is measured in optimum common electrode voltage.

Note 8-2 : Topcon BM-7(fast) luminance meter 2° field of view is used in the testing (after 20~30 minutes' operation).

Note 8-3 : The definitions of viewing angle diagrams:

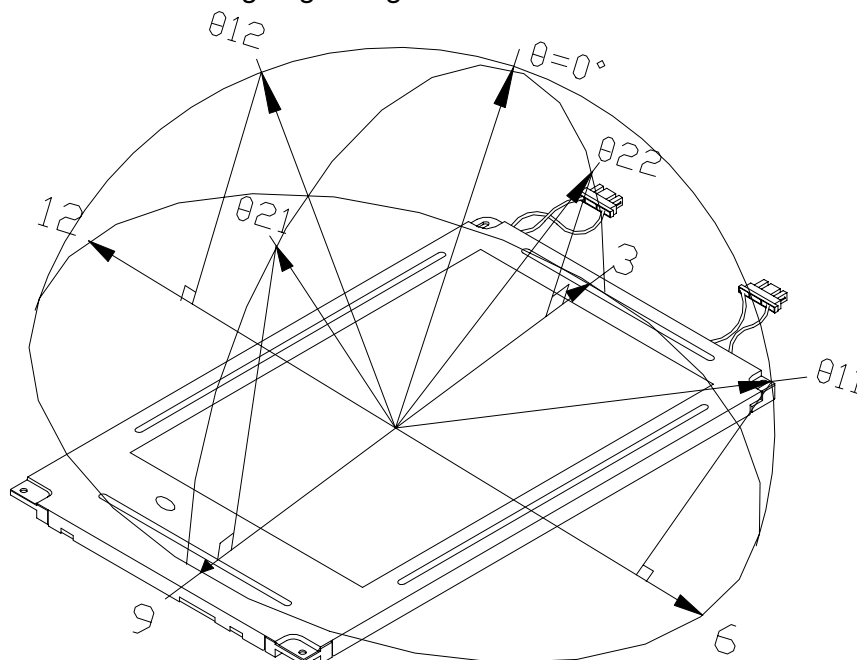

Note 8-4: Cross Talk (CTK) = $\frac{|YA-YB|}{YA} \times 100\%$

YA: Brightness of Pattern A

YB: Brightness of Pattern B
Pattern A

(Gray Level 46)

Pattern B

(Gray Level 46, central
black box exclusive)

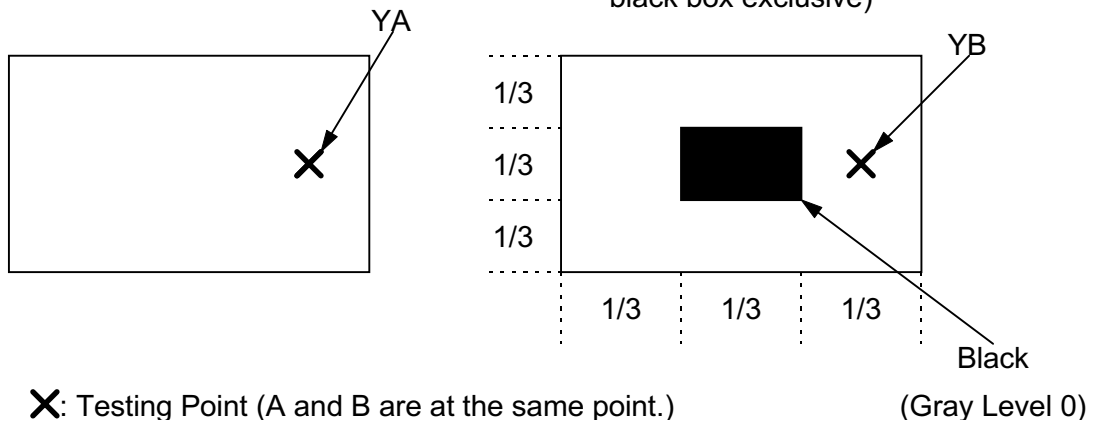

X: Testing Point (A and B are at the same point.)

(Gray Level 0)

9. Reliability Test

No	Test Item	Test Condition
1	High Temperature Storage Test	Ta = +70 °C, 240 hrs
2	Low Temperature Storage Test	Ta = -25 °C, 240 hrs
3	High Temperature Operation Test	Ta = +55 °C, 240 hrs
4	Low Temperature Operation Test	Ta = 0 °C, 240 hrs
5	High Temperature & High Humidity Operation Test	Ta = +40 °C, 95%RH, 240 hrs
6	Vibration Test (non-operating)	Frequency : 10 ~ 57 Hz/Vibration Width :0.075mm 58-500 H// Gravity :9.8m/s ² Sweep time: 11 minutes Test period: 3 hrs for each direction of X, Y, Z
7	Shock Test (non-operating)	Gravity :490m/s ² Direction: ± X, ± Y, ± Z Pulse Width :11ms, half sine wave

Ta: ambient temperature

[Judgement Criteria]

Under the display quality test conditions with normal operation state , there should be no change which may affect practical display function.

10. Block Diagram

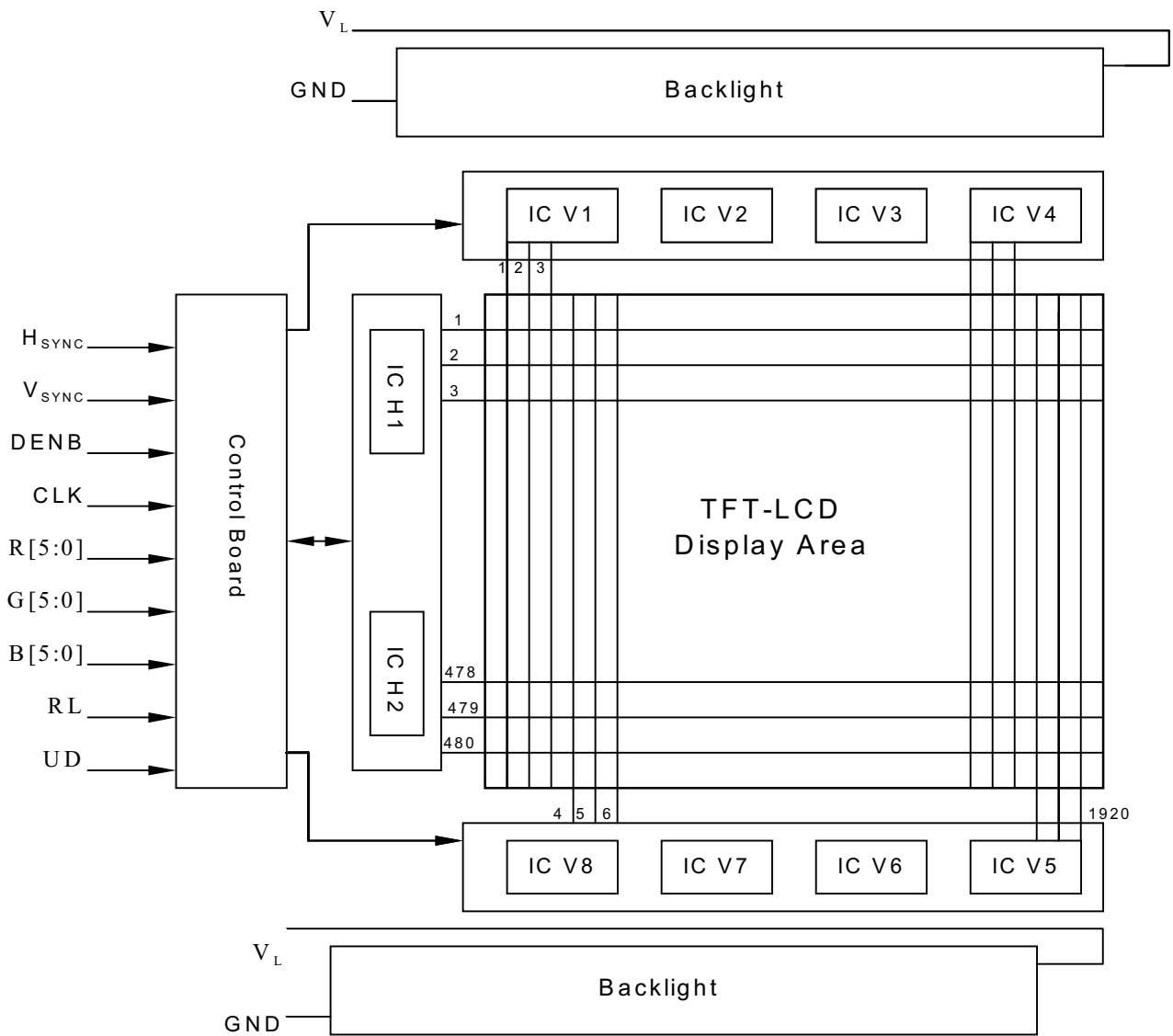

11. Packing Diagram

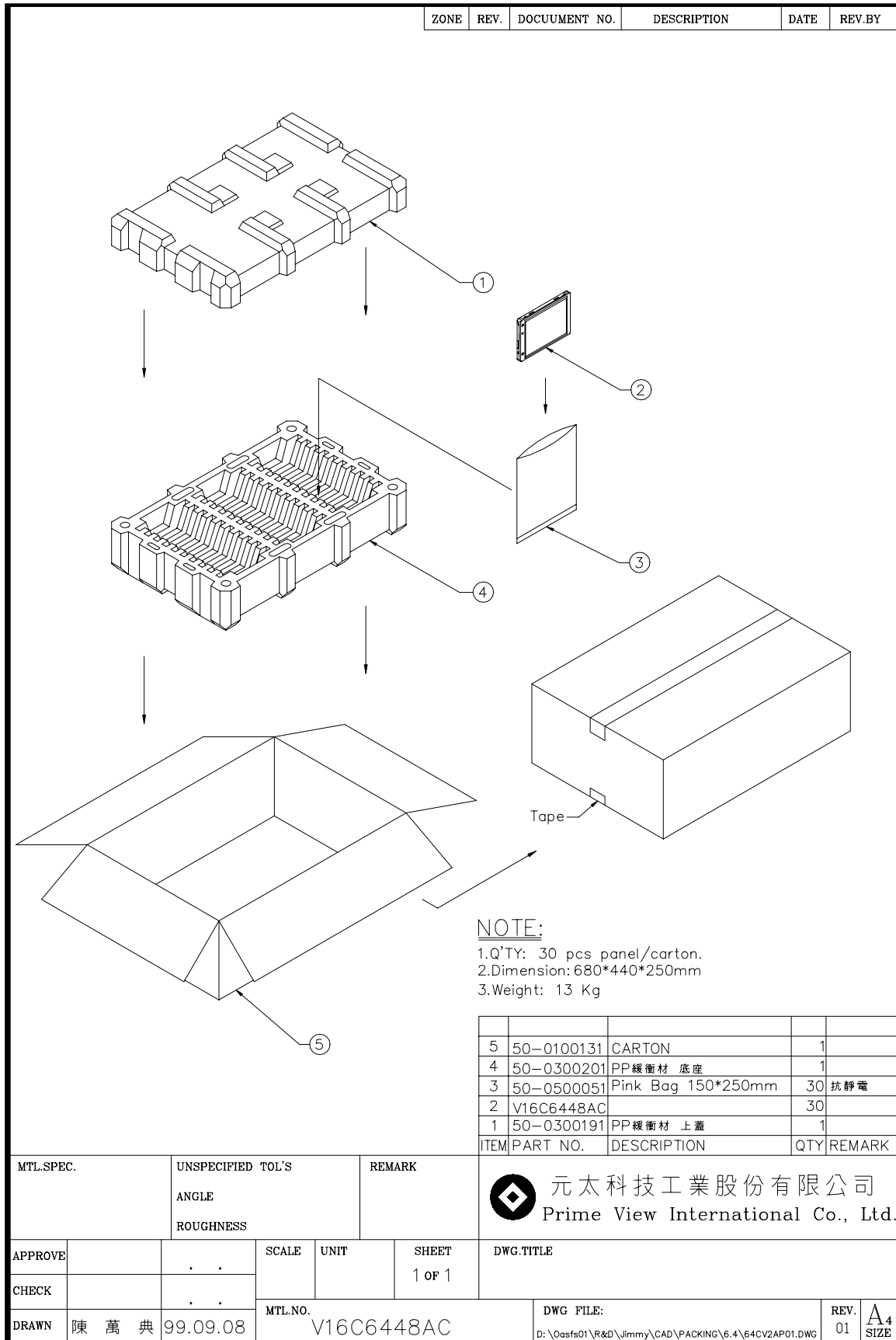

Revision History

Rev.	Issued Date	Revised Contents
1	Jan. 19, 2000	NEW
1.1	Aug.16	7. Electrical Characteristics Modify 7-8 Control Board Dip Switch Format(SW2-1 ON)
1.2	Oct. 24 ,2000	5. Input / Output Terminals Modify note 5-2(R/L) and note 5-3(U/D) define.